

# ★ Snap-Tite **H, IH & PH Series -- Couplings for Hydraulic, Pneumatic and General Purpose Use**

*Featuring...Snap-tite quality with built in reliability and flow characteristics over the competition.*



## **Advantages of H Series**

- **Sizes** — 1/8" – 4"
- **Metals** — H Series Quick Disconnect Couplings are available in four metals – steel, brass, aluminum and 316 stainless steel. A variety of protective finishes are available. Please consult factory.
- **Seal Versatility** — Wide choice of standard and special seal materials enable the H, IH & PH series to handle a great variety of fluids.
- **Sleeve Lock** — Sleeve lock option aids in preventing accidental disconnection of the coupling. To disconnect, align the pin in the body with the slot in the sleeve and retract sleeve.
- **(Valve & Valve) Quick Disconnect Low Pressure Drop** — The two-piece body construction permits larger flow passages than the designated size of the coupling, permitting greater flow while maintaining low pressure drop and provides end fitting versatility.
- **Smooth Flow** — Snap-tite's "Jet Stream" valve design helps maintain a clean linear flow. Positive positioning of the valve aids in maintaining a steady, even flow under normal working conditions.
- **Flow on Connection** — Valves are designed to automatically open in both the coupler and nipple halves when the unit is connected permitting maximum free flow.
- **Shut-off On Disconnection** — Valves are designed to automatically close under normal usage conditions in both the coupler and nipple halves when the unit is disconnected.
- **Fast Efficient Operation** — Connect or disconnect in seconds. To connect, pull back the sleeve, insert the nipple into the coupler and release the sleeve. To disconnect, pull back the sleeve, remove the nipple and the halves are disconnected.
- **Dependable Operation** — Ball-lock mechanism provides positive connection. Hardened stainless steel balls along with a radiused and induction hardened (steel) ball race gives extended life to the H Series couplings.
- **Positive Sealing Connected** — Two types of seals are available with H Series quick disconnects.
  - **Molded U-Packer Seal** – Standard for all sizes; provides contact over several times the normal O-ring sealing area. The unique U-packer seal design embodies a self-energizing feature that permits a positive seal at all pressures. The design also enables the coupling to seal under adverse conditions such as side load, scratches on the nipple from usage abuse or dirt on the nipple.
  - **Optional Seal (-9)** – Can be supplied as standard in place of the U-Packer seal in steel and stainless steel construction in sizes 1/4" thru 1-1/4". Designed for use with high pressure, multiple-cycle hydraulic or pneumatic applications, the seal set consists of a standard O-ring and a Teflon back-up ring. This seal configuration prevents the seal from extruding under multiple-cycle high flow and pressure surge applications.
- **Positive Sealing Disconnected** — The metal to metal contact of the valve with the coupler or nipple body is designed to control compression of the valve seal eliminating wear and increasing seal life.

H Series quick disconnects have been proven by years of use on hydraulic-pneumatic applications and in handling of many gases and fluids. The H Series fully engineered design meets or exceeds MIL-C-51234 and provides superior flow characteristics with built in reliability.

**PH Option** — Has the same advantages built into the H Series with the addition of an instant, automatic bleed-off valve built into the valve for fast, easy connection of hydraulic lines and for other applications that call for periodic connection against trapped static hydraulic pressure. The PH option can be placed in either the valve coupler or the valve nipple and are completely interchangeable with the H Series coupler or nipple.

The PH option has successfully been field tested in connecting against static pressures up to 3,000 psi (210 bar). Available in steel, zinc yellow dichromate plated, in sizes 3/8", 1/2", 3/4" and 1".

**IH Option** — The IH Series is identical to the H Series except for the valve which was designed specifically for durability when used in pneumatic systems using reciprocating, pulsating and rotary motion air tools. Cylindrical construction of the IH valve provides 360° contact with the plain H Series nipple. This permits repeated cycling while enabling efficient operation and long life. Available in steel, zinc yellow dichromate plated. Sizes 1/4", 3/8", 1/2" and 3/4".

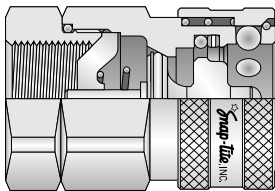

**-9 Option**

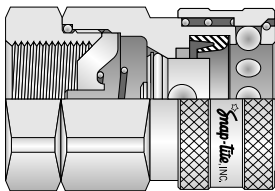

**IH Option**

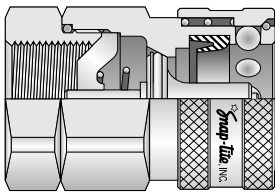

**PH Option**

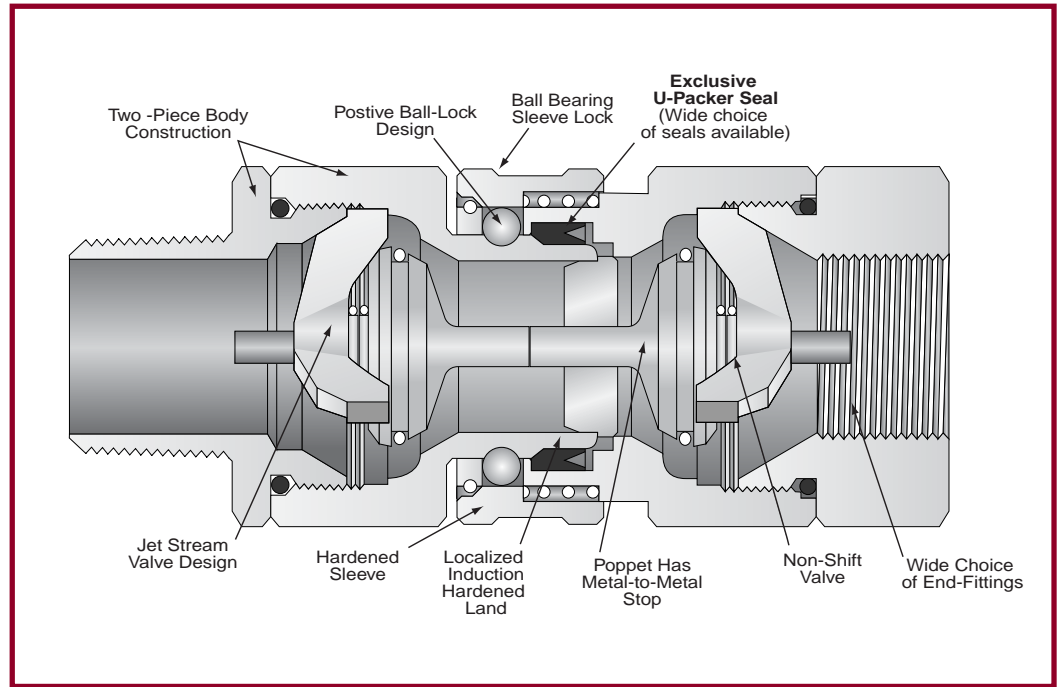

### WORKING PRESSURES\*

Quick Disconnect Size	Valve & Valve (Double Shut-off) Valve & Plain (Single Shut-off)								Plain & Plain (No Shut-off)							
	Steel		Aluminum		Brass		Stainless Steel		Steel		Aluminum		Brass		Stainless Steel	
	psi	bar	psi	bar	psi	bar	psi	bar	psi	bar	psi	bar	psi	bar	psi	bar
1/4"	6500	448	2250	155	2250	155	5000	345	11000	759	4000	276	4000	276	10000	690
3/8"	4500	310	2250	155	2250	155	4000	276	11000	759	4000	276	4000	276	8000	552
1/2"	4000	276	1750	121	2000	138	3750	259	11000	759	4000	276	4000	276	8000	552
3/4"	3500	241	1750	121	2000	138	2000	138	9000	621	3500	241	3500	241	7000	483
1"	2000	138	1500	103	1750	121	2000	138	6000	414	3000	207	3000	207	4000	276
1-1/4"	1750	121	375	26	350	24	1500	103	5000	345	1000	69	1000	69	3000	207
1-1/2"	1500	103	375	26	350	24	1500	103	5000	345	1000	69	1000	69	3000	207
2"	1500	103	300	21	400	28	500	34	4000	276	750	52	750	52	1000	69
2-1/2"	1000	69	300	21	400	28	400	28	1000	69	300	21	400	28	400	28
3"	750	52	200	14	200	14	400	28	750	52	200	14	200	14	400	28
4"	500	34	150	10	150	10	300	21	500	34	150	10	150	10	300	21

**NOTE:** Pressure ratings were established under static pressure conditions. Therefore, pressure ratings for any given flow, pressure surge, and/or vibration may vary from these ratings.

### Pressure and Flow Data

Pressure ratings of standard quick disconnects can be increased for some applications by slight design modifications or if specific operating conditions are met. On applications requiring higher ratings than those listed or pressure surges, please consult the factory. Burst pressures listed were taken at the point at which failure rendered the quick disconnect inoperative. (Proof pressure equals 1-1/2 times the working pressure; burst pressure equals 2 times working pressure.)

\*For Det Norske Veritas (DNV) compliance, divide the working pressures shown by 2.

## H SERIES

**Valved and Valved (Double Shut-off)**

FLOW RATE (LPM)

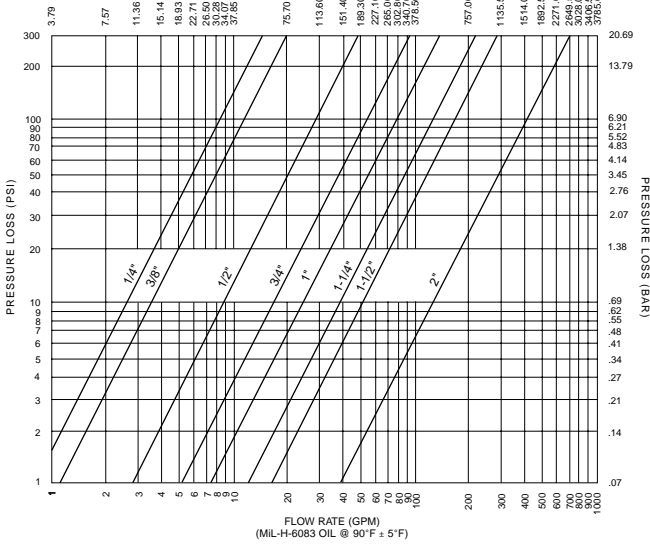

## IH SERIES

CFM FREE AIR AT 17.7 PSIA, 70°F

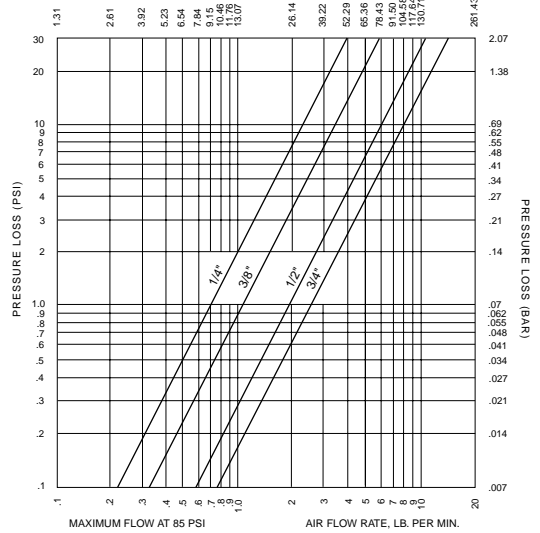

**Valved and Plain (Single Shut-off)**

FLOW RATE (LPM)

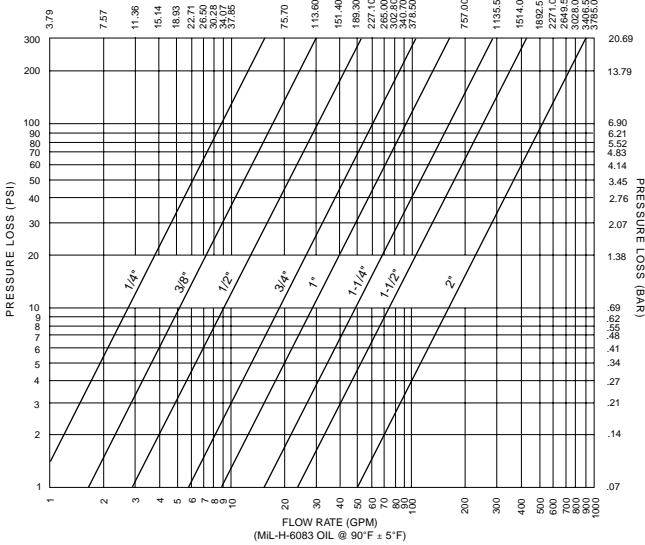

## PH SERIES

**Valved and Valved (Double Shut-off)**

FLOW RATE (LPM)

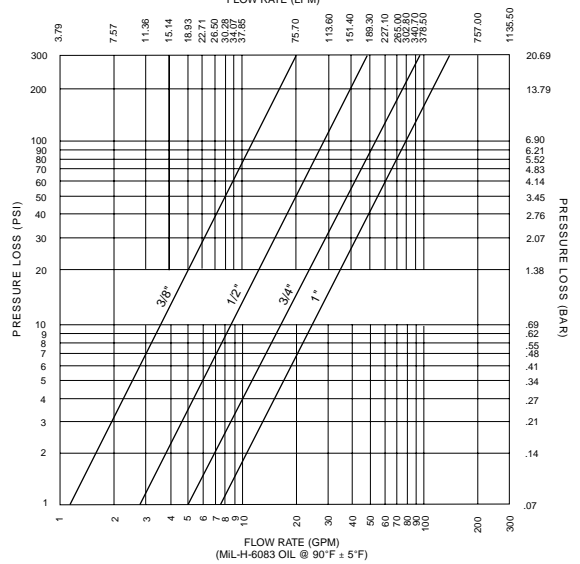

# COUPLING COMBINATIONS & END FITTINGS

1. Double shut-off coupling: Valve coupler and valve nipple
  2. Single shut-off coupling: Valve coupler and plain nipple
  3. No shut-off or straight through: Plain coupler and plain nipple. Plain couplers cannot be used with valve nipples.
- All combinations of the same size are interchangeable regardless of material, finish or end fittings.

## VALVE

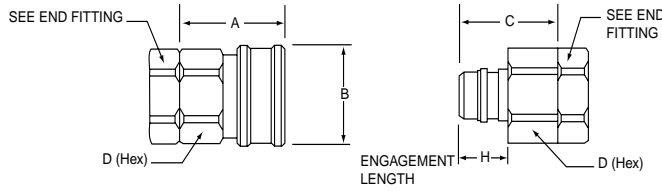

Size		1/4"	3/8"	1/2"	3/4"	1"	1-1/4"	1-1/2"	2"	2-1/2"	3"	4"
<b>A</b>	in	1.34	1.50	1.62	1.92	2.07	2.28	2.57	3.14	3.63	3.88	4.58
	mm	34.04	38.10	41.15	48.77	52.58	57.91	65.28	79.76	92.20	98.55	116.33
<b>B</b>	in	1.00	1.19	1.39	1.63	2.00	2.19	2.75	3.50	4.50	5.45	6.75
	mm	25.40	30.23	35.31	41.40	50.80	55.63	69.85	88.90	114.30	138.13	171.45
<b>C</b>	in	1.28	1.44	1.51	1.79	1.95	2.15	2.41	2.94	3.42	3.79	4.47
	mm	32.51	36.58	38.35	45.47	49.53	54.61	61.21	74.68	86.87	96.27	113.54
<b>D<sup>2</sup></b>	in	.88	1.00	1.19	1.50	1.88	2.00	2.75	3.75	4.50	4.75	6.75
	mm	22.35	25.40	30.23	38.10	47.75	50.80	69.85	95.25	114.30	120.65	171.45
<b>H</b>	in	.58	.71	.72	.88	.91	.90	1.06	1.32	1.41	1.56	1.93
	mm	14.73	18.03	18.29	22.35	23.11	22.86	26.92	33.53	35.81	39.62	49.02

## END FITTINGS<sup>1</sup>

		Size	1/4"	3/8"	1/2"	3/4"	1"	1-1/4"	1-1/2"	2"	2-1/2"	3"	4"
<b>Male Tapered Pipe</b> 	<b>F</b>	in	.75	.69	.95	.96	1.14	1.31	1.44	1.40	1.83	1.88	2.88
		mm	19.05	17.53	24.13	24.38	28.96	33.27	36.58	35.56	46.48	47.75	73.15
	<b>G<sup>2</sup></b>	in	.88	1.00	1.19	1.50	1.88	2.00	2.50	3.50 <sup>3</sup>	4.00	4.75	6.00
		mm	22.35	25.40	30.23	38.10	47.75	50.80	63.50	88.90 <sup>3</sup>	101.60	120.65	152.40
<b>EM Male SAE Flared and MS33656</b> 	<b>F</b>	in	.74	.74	.84	1.13	1.16	1.27	1.46	1.71			
		mm	18.80	18.80	21.34	28.70	29.46	32.26	37.08	43.43			
	<b>G<sup>2</sup></b>	in	.88	1.00	1.19	1.50	1.88	2.00	2.50	3.50 <sup>3</sup>			
		mm	22.35	33.27	30.23	38.10	47.75	50.80	63.50	88.90 <sup>3</sup>			
<b>MS33657</b> 	<b>F</b>	in	1.23	1.31	1.47	1.84	1.84	1.95					
		mm	31.31	33.27	37.34	46.74	46.74	49.53					
	<b>G<sup>2</sup></b>	in	.88	1.00	1.19	1.50	1.88	2.00					
		mm	22.35	25.40	30.23	38.10	47.75	50.80					
<b>Female Tapered Pipe</b> 	<b>F</b>	in	.31	.40	.47	.50	.60	1.26	.70	.78	.90	.88	1.13
		mm	7.87	10.16	11.94	12.70	15.24	32.00	17.78	19.81	22.86	22.35	28.70
	<b>G<sup>2</sup></b>	in	.88	1.00	1.19	1.50	1.88	2.00	2.50	3.50	4.00	4.75	6.00
		mm	22.35	25.40	30.23	38.10	47.75	50.80	63.50	88.90	101.60	120.65	152.40
<b>EF Female Straight and MS33649</b> 	<b>F</b>	in	.46	.70	.57	1.00	.87	1.11	.85	1.01			
		mm	11.68	17.78	14.48	25.40	22.10	28.19	21.59	25.65			
	<b>G<sup>2</sup></b>	in	.88	1.00	1.19	1.50	1.88	2.00	2.50	3.50			
		mm	22.35	25.40	30.23	38.10	47.75	50.80	63.50	88.90			
<b>EB Male SAE Bulk-Head</b> 	<b>F</b>	in	1.39	1.56	1.67	2.03	1.84	2.14					
		mm	35.30	39.62	42.42	51.56	46.74	54.36					
	<b>G<sup>2</sup></b>	in	.88	1.00	1.19	1.50	1.88	2.00					
		mm	22.35	25.40	30.23	38.10	47.75	50.80					
<b>Female RP<sup>4</sup> British Parallel</b> 	<b>F</b>	in	.39	.40	.53	.56	.60	1.26	.70	.78	.90	.88	1.13
		mm	9.91	10.16	13.46	14.22	15.24	32.00	17.78	19.81	22.86	22.35	28.70
	<b>G<sup>2</sup></b>	in	.88	1.00	1.19	1.50	1.88	2.00	2.50	3.50	4.00	4.75	6.00
		mm	22.35	25.40	30.23	38.10	47.75	50.80	63.50	88.90	101.60	120.65	152.40

**PLAIN FEMALE PIPE**

**PLAIN FEMALE RP<sup>4</sup>**

**PLAIN MALE PIPE**

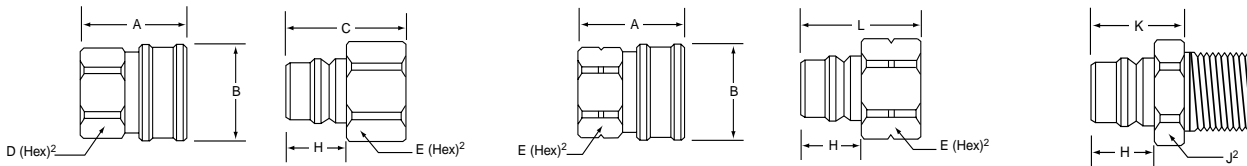

Size		1/4"	3/8"	1/2"	3/4"	1"	1-1/4"	1-1/2"	2"	2-1/2"	3"	4"
<b>A</b>	in	1.34	1.50	1.62	1.91	2.07	2.28	2.57	2.48	3.11	3.35	3.88
	mm	34.04	38.10	41.15	48.51	52.58	57.91	65.28	62.99	78.99	85.09	98.55
<b>B</b>	in	1.00	1.19	1.39	1.63	2.00	2.19	2.75	3.50	4.50	5.45	6.75
	mm	25.40	30.23	35.31	41.40	50.80	55.63	69.85	88.90	114.30	138.43	171.45
<b>C</b>	in	1.32	1.52	1.72	1.92	2.10	2.22	2.44	2.60	2.95	3.40	3.73
	mm	33.53	38.61	43.69	48.77	53.34	56.39	61.98	66.04	74.93	86.36	94.74
<b>D<sup>2</sup></b>	in	.88	1.00	1.19	1.50	1.88	2.00	2.50	3.25	3.75	4.75	5.50
	mm	22.35	25.40	30.23	38.10	47.75	50.80	63.50	82.55	95.25	120.65	139.70
<b>E<sup>2</sup></b>	in	.63	.81	1.00	1.19	1.50	1.88	2.13	2.75	3.25	4.00	5.00
	mm	16.00	20.57	25.40	30.23	38.10	47.75	54.10	69.85	82.55	101.60	127.00
<b>H</b>	in	.58	.71	.72	.88	.91	.90	1.06	1.32	1.41	1.56	1.93
	mm	14.73	18.03	18.29	22.35	23.11	22.86	26.92	33.53	35.81	39.62	49.02
<b>K</b>	in	.78	.98	1.01	1.14	1.16	1.17	1.34	2.03	2.08	2.59	2.58
	mm	19.81	24.89	25.65	28.96	29.46	29.72	34.04	51.56	52.83	65.79	65.53
<b>J<sup>2</sup></b>	in	.56	.69	.88	1.06	1.38	1.88	2.13	2.50	3.25	4.00	5.00
	mm	14.22	17.53	22.35	26.92	35.05	47.75	54.10	63.50	82.55	101.60	127.00
<b>L</b>	in	1.27	1.44	1.72	1.86	2.13	2.22	2.44	2.60	2.95	3.40	3.73
	mm	32.26	36.58	43.69	47.24	54.10	56.39	61.98	66.04	74.93	86.36	94.74

<sup>1</sup> Other special end fittings available upon request.

<sup>2</sup> Dimensions taken across the hex flats. Round stock with two milled flats may be substituted for hex stock. Dimensions across flats same as dimensions across hex flats. Max O.D. of round stock will not exceed the dimensions across the points of the hex stock. Valve coupler and nipple bodies may be supplied from round bar stock without wrench flats.

<sup>3</sup> 3.5" (88.9 mm) across hex flats - may substitute 3.75" (95.25 mm) round with 3.38" (85.85 mm) across wrench flats.

<sup>4</sup> Notch on Hex indicates RP British parallel threads.

**ACCESSORIES**

Dust caps, dust plugs and pressure caps protect disconnected coupler and nipple from damage, dirt and other contaminants. Dust caps and dust plugs are available in plastic and clear anodized aluminum.

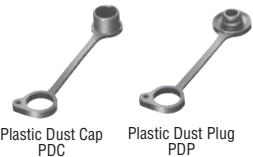

Plastic Dust Cap PDC Plastic Dust Plug PDP

**Plastic Caps and Plugs**

Inexpensive means to protect your investment against contamination and damage. Comes with a loop to fit over pipe fitting or affixing to equipment with sheet metal screw. Available in sizes 1/4" thru 1".



Metal Dust Plug AMPH Metal Dust Cap ADCH

**Aluminum Dust Caps and Plugs**

Alternate method to protect your equipment – aluminum dust caps and plugs are available in sizes 1/4" thru 3". The 1/4" thru 3/4" sizes come with 10" chrome plated brass bead chain. The 1" and above come with steel zinc plated sash chain.



Metal Pressure Cap MCH

**Pressure Caps**

Pressure-tight pressure caps for nipples are standard in steel, zinc yellow dichromate plated. Other materials such as brass, aluminum and stainless steel available on special order. Sizes available 1/4" thru 3". Sizes 1/4" thru 3/4" come with 10" length of corrosion resistant steel cable. Sizes 1" thru 3" come with 12" of cable-all with adjustable loop at end of cable. Consult factory for special lengths and part number.

SIZES	PLASTIC PLUG	PLASTIC CAP	ALUMINUM PLUG	ALUMINUM CAP	PRESSURE CAP
1/4"	PDP-4	PDC-4	AMPH-4	ADCH-4	MCH-4
3/8"	PDP-6	PDC-6	AMPH-6	ADCH-6	MCH-6
1/2"	PDP-8	PDC-8	AMPH-8	ADCH-8	MCH-8
3/4"	PDP-12	PDC-12	AMPH-12	ADCH-12	MCH-12
1"	PDP-16	PDC-16	AMPH-16	ADCH-16	MCH-16
1-1/4"			AMPH-20	ADCH-20	MCH-20
1-1/2"			AMPH-24	ADCH-24	MCH-24
2"			AMPH-32	ADCH-32	MCH-32
2-1/2"			AMPH-40	ADCH-40	MCH-40
3"			AMPH-48	ADCH-48	MCH-48



**! WARNING !**

FAILURE OR IMPROPER SELECTION OR IMPROPER USE OF THE PRODUCTS AND/OR SYSTEMS DESCRIBED HEREIN OR RELATED ITEMS CAN CAUSE DEATH, PERSONAL INJURY AND PROPERTY DAMAGE.

*This document and other information from Snap-tite, Inc., its subsidiaries and authorized distributors provide product and/or system options for further investigation by users having technical expertise. It is important that you analyze all aspects of your application and review the information concerning the product or system in the current product catalog. Due to the variety of operation conditions and applications for these products or systems, the user, through its own analysis and testing, is solely responsible for making the final selection of the products and systems and assuring that all performance, safety and warning requirements of the application are met.*

*The products described herein, including without limitation, product features, specifications, designs, availability and pricing, are subject to change by Snap-tite, Inc. and its subsidiaries at any time without notice.*



**Quick Disconnect & Valve Division**  
201 Titusville Road  
Union City, Pennsylvania 16438-8699 USA  
PH: 814-438-3821 FAX: 814-438-3069  
e-mail: [qd&v\\_sales@snap-tite.com](mailto:qd&v_sales@snap-tite.com)  
[www.snap-tite.com](http://www.snap-tite.com)



Industrial Estate  
Whitemill - Wexford  
Republic of Ireland  
PH: 353-53-41566 FAX: 353-53-41582  
e-mail: [ste\\_sales@snap-tite.com](mailto:ste_sales@snap-tite.com)  
[www.snap-tite.com](http://www.snap-tite.com)

DISTRIBUTED BY:

**ISO-9001 Certified**